

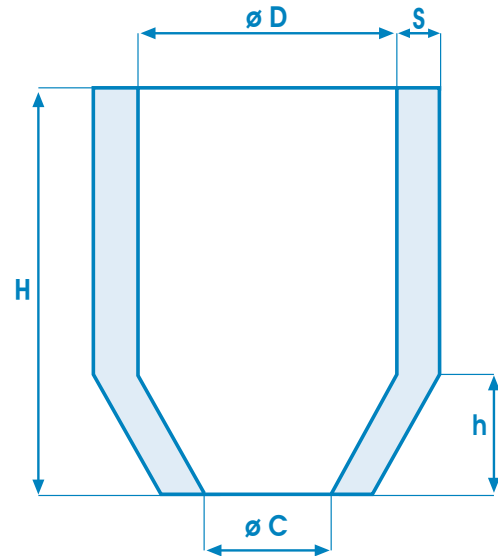

# MANCHONS TRONCONIQUES ISO-EXO TERMIK EXO 23 - EXO 25B - EXO 27

TYPE **SX**



TYPE	D mm	C mm	H mm	h mm	S mm			Volume dm <sup>3</sup>	Module Termik
					27	23	25B		
SX1	40	17	75	25	11	9	0,08	1,20	
SX2	60	45	90	30	12	10	0,24	1,80	
SX3	80	50	150	40	13	11	0,69	2,40	
SX4	100	55	150	40	15	12	1,06	2,90	
SX5	20	65	150	40	16	13	1,52	3,30	
SX6	140	80	200	40	19	16	2,85	4,00	
SX150	150	75	200	40	19	16	3,26	4,10	
SX7	160	90	200	40	21	17	3,72	4,30	
SX8	180	110	200	40	22	18	4,74	4,60	
SX9	200	120	200	60	23	19	5,74	4,80	
SX10	250	155	200	50	25	20	8,84	5,60	
SX11	300	185	200	80	26	21	12,15	6,00	

Date d'émission  
JUILLET 2015

Autorisation Direction

## TOLÉRANCES

DIMENSION	DIAMÈTRE	ÉPAISSEUR	HAUTEUR
30-100	± 5 mm	-2 mm	-10 mm
110-200	± 5 mm	-2 mm	-10 mm
220-300	± 5 mm	-3 mm	-10 mm